

CHAOS

To

COUTURE



1



2



3



4



5



6



7

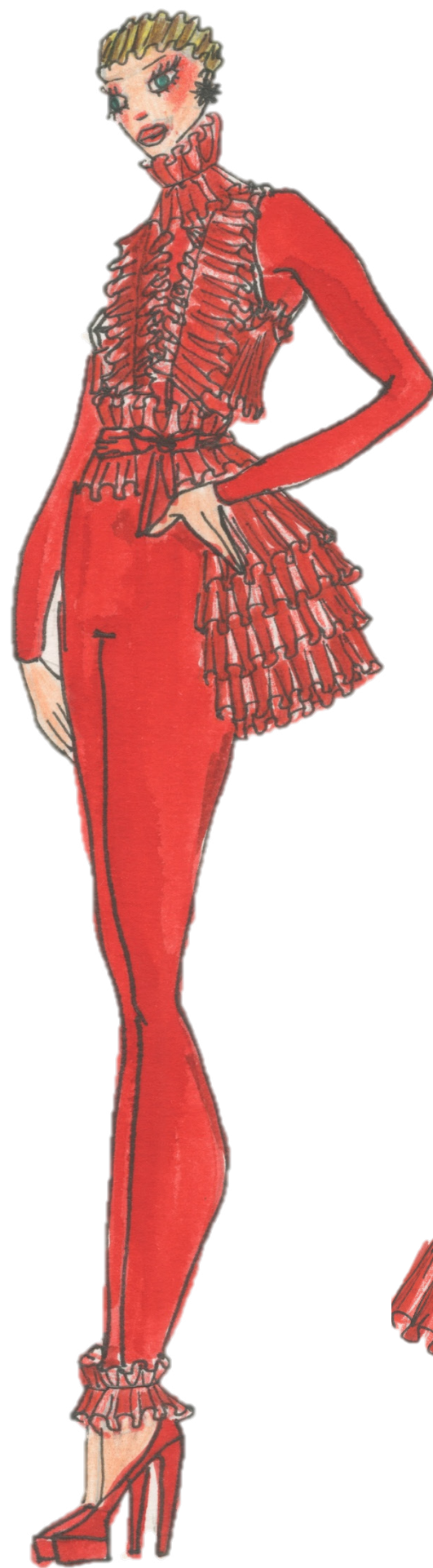

8

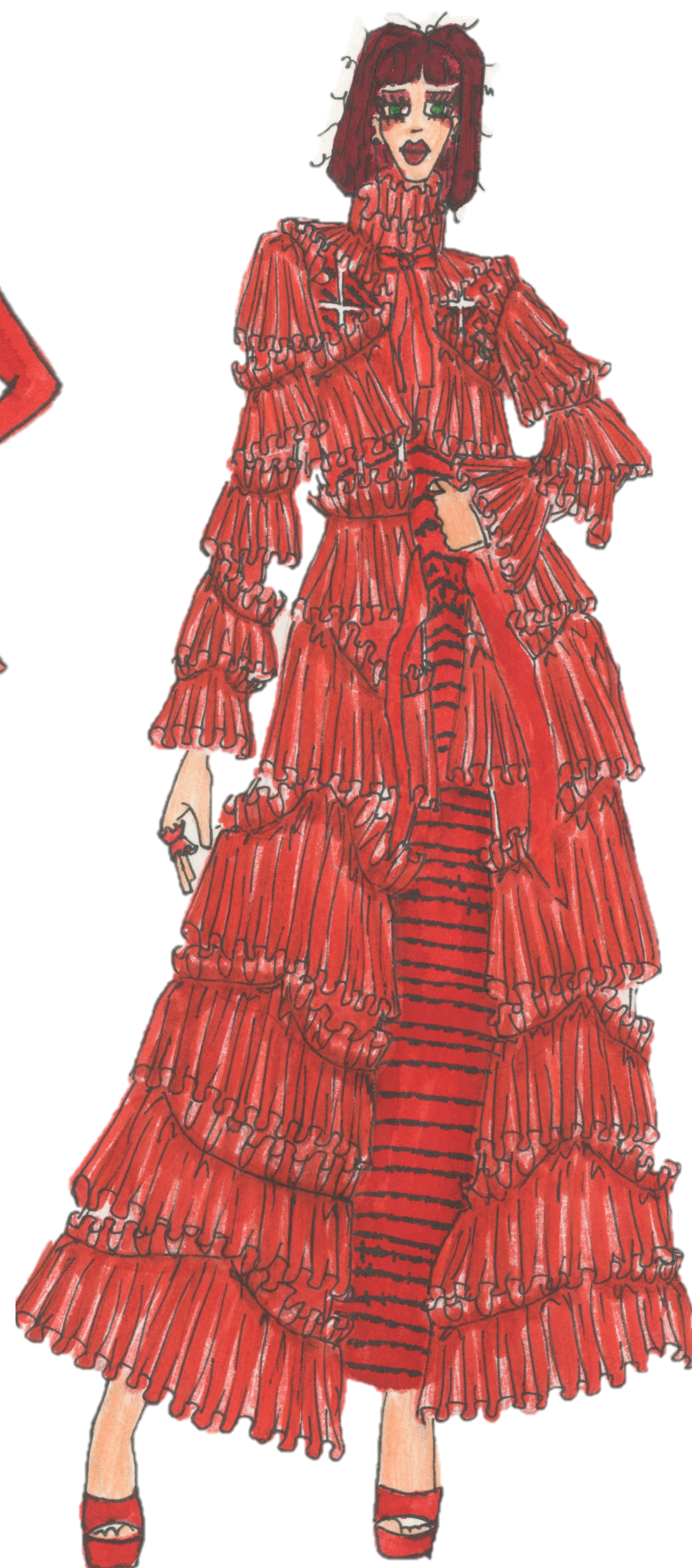

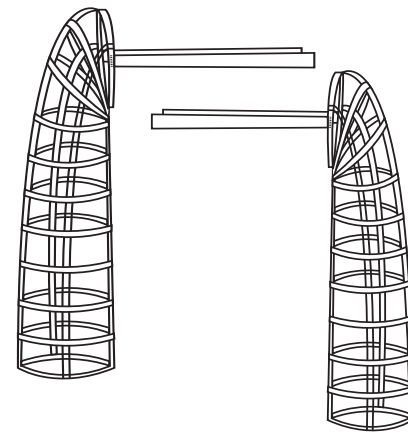
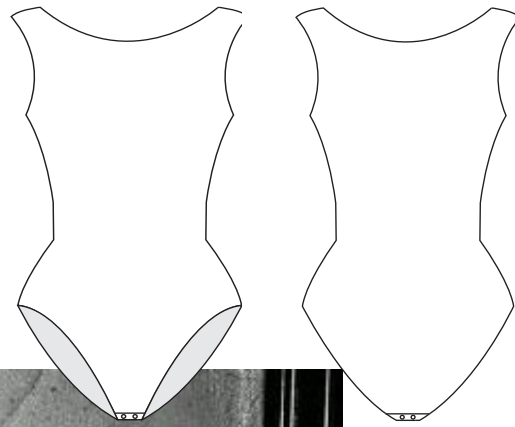

4 metres length by 40cm width
 sew 7cm from the to edge
 make 20
 gather and hand stitch 10 to the cage-
 and 10 to the sleeves

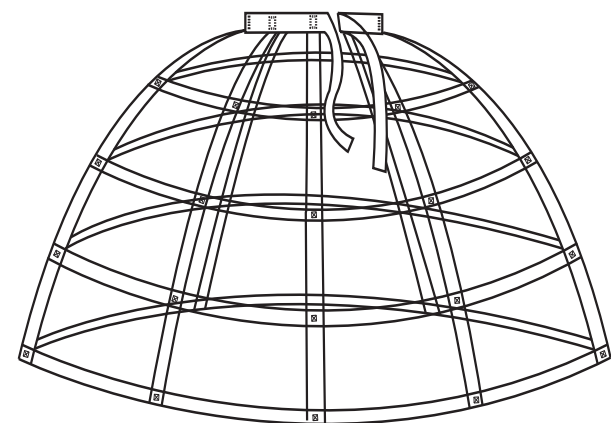
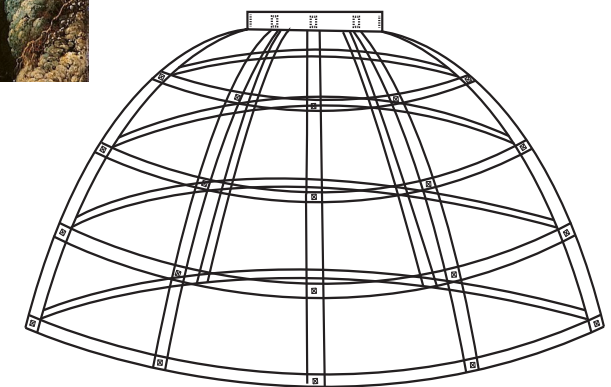





CAGE
SKIRT



cage made of boning covered by white satin cut on bias

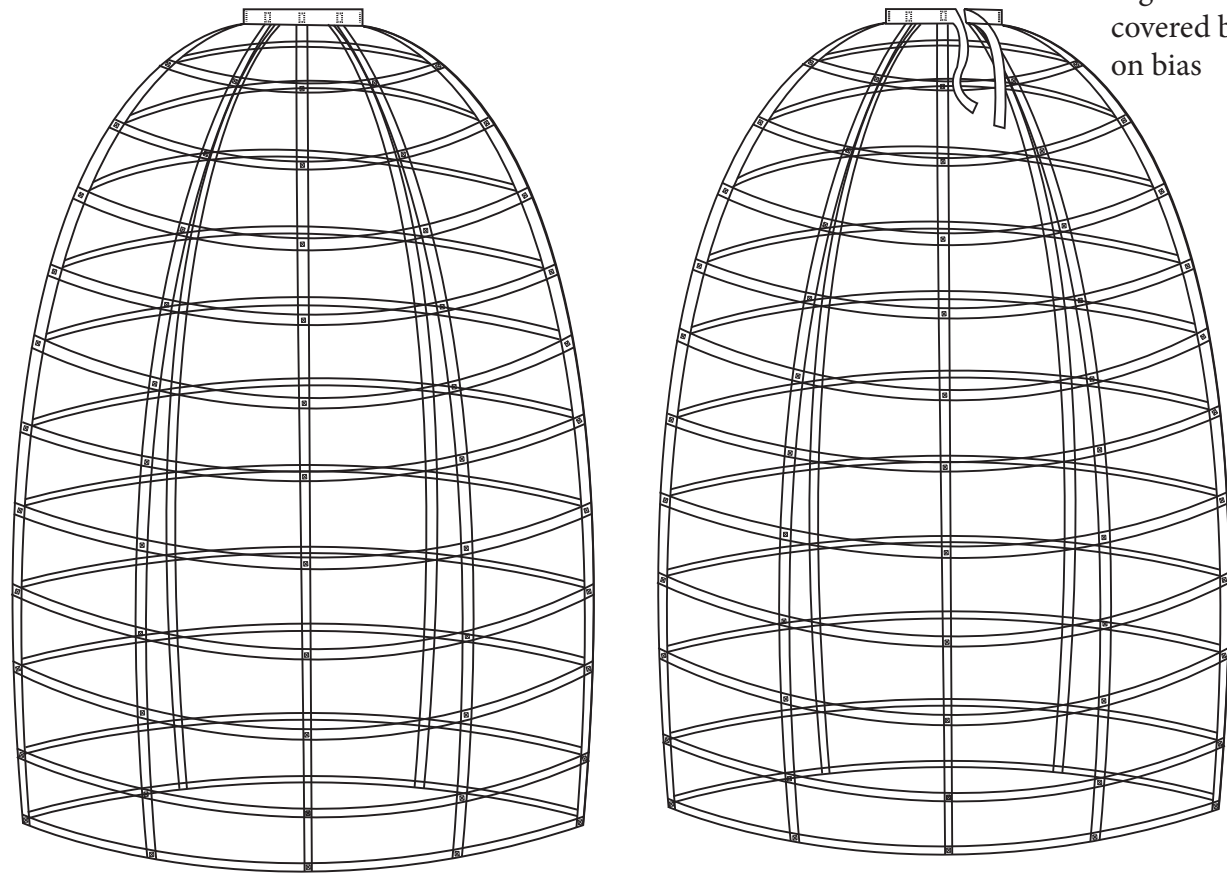

MEASUREMENTS & NOTES ON B&G CAGE

WAIST = 68 cm
 DISTANCE BETWEEN VERTICAL PIECES ON WAIST = 7.6 cm
 DISTANCE BETWEEN HORIZONTAL PIECES = 10 cm
 LONG VERTICAL PIECES = 161.5 cm + 27.5 cm = 189 cm
 ↳ 1.5 cm for ease at the top

1st hoop = 14.2 cm
 2nd hoop = 18 cm
 3rd hoop = 20 cm
 4th hoop = 20 cm
 5th hoop = 20 cm
 6th hoop = 20 cm
 7th hoop = 20 cm
 8th hoop = 20 cm
 9th hoop = 20 cm
 10th hoop = 20 cm
 11th hoop = 20 cm

when cutting the strips of fabric (satin) add 2 cm or more (not too much) to their fold it to close the strips after the boning is added

162.5 28.5 + 158.5 = 187
 28.5 - 28.5 = 0
 181.0

Long vertical strips boning = 127.5 cm 115.0 cm
 Long vertical strips satin = 130 cm

BONING

hoop 1 = 139.5 cm + 2 cm = 141.5 cm
 hoop 2 = 162.5 cm + 2 cm = 164.5 cm
 hoop 3 = 181.0 cm + 2 cm = 183.0 cm
 hoop 4 = 181.0 cm + 2 cm = 183.0 cm

same for all the other 8 hoops
 ↳ use the boning strips inside + the last hoop to make it more firm.

Long vertical

1 = 125 cm - 115
 2 = 124 cm - 115
 3 = 124 cm - 115
 4 = 119.5 cm - 115
 5 = 116 cm - 115
 6 = 117.5 cm - 115
 7 = 119 cm - 115
 8 = 124 cm - 115
 9 = 119.5 cm - 115
 10 = 115
 11 = 115

4 metres long by 40 cm width, gathered becomes 189 cm. Make 25 and hand stitch on the cage after gathered.

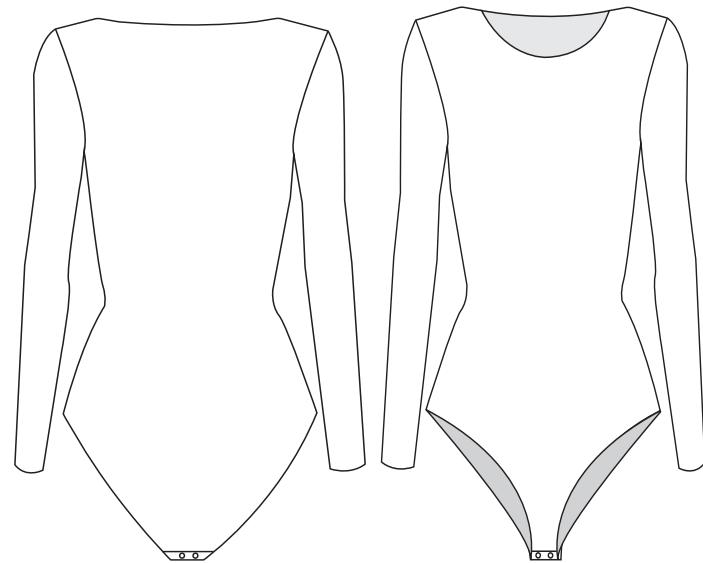

GATHERING

1st STEP - make a 10 by 10 cm sample to measure the changes after gathering before gathering

10 x 10 cm = $\frac{10}{10}$

AFTER GATHERING

4 x 10 cm = $\frac{4}{10}$

WAIST = 68 cm = 75 cm to make sure it is enough (leave 3 cm on both edges)

SAMPLES =
 1 with WHITE THREAD TO SEE THE MEASUREMENTS
 1 with ORANGE THREAD (B&G) = ✓ stronger

RATIO TO MEASURE DESIRED FINAL FABRIC

OR: ORIGINAL WIDTH = 10 cm
 GATHERED WIDTH = 4 cm

RATIO = $\frac{ow}{gw}$
 RATIO = $\frac{10 \text{ cm}}{4 \text{ cm}} = 2.5$

DESIRED LENGTH = 75 cm

FABRIC NEEDED = DESIRED FINAL LENGTH x RATIO
 FABRIC NEEDED = 75 cm x 2.5 cm = 187.5 cm

SO CUT 187.5 cm OF FABRIC WHICH WILL THEN BECOME 75 cm FOR THE WAIST.

GATHERING FOR THE WAIST

↳ 187.5 cm length x 2 (make two)

↳ 4 x 40 cm width (4 cm)

↳ START GATHERING AT 7 cm from the top edge. (6 lines)



3 metres length by 20 cm width
make 4

sew onto the bottom edge of the jumpsuit

4 metres length by 20 cm width
make 10 and hand stitch to cage jacket

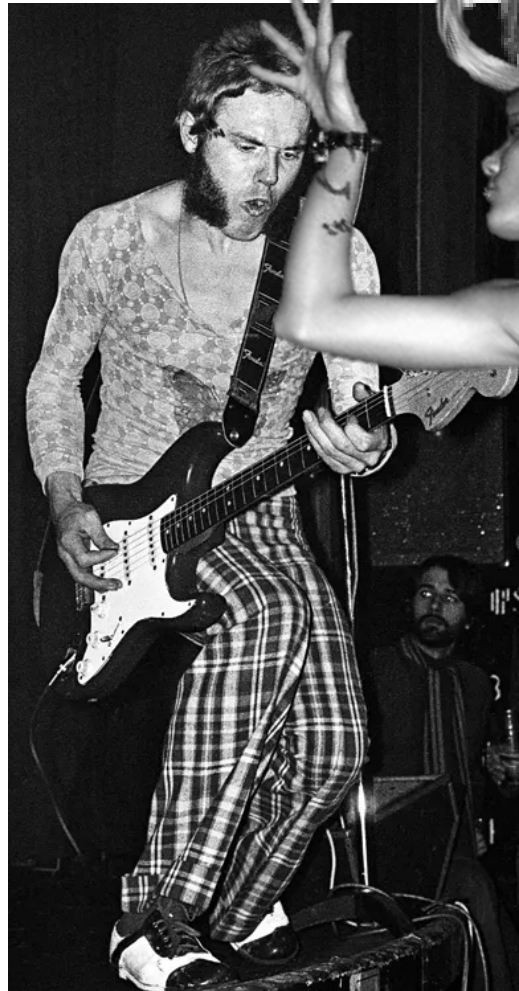
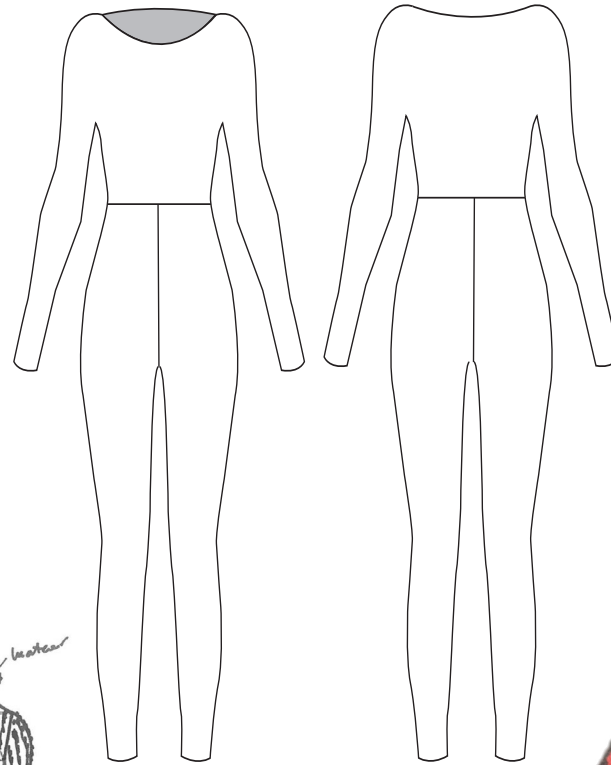
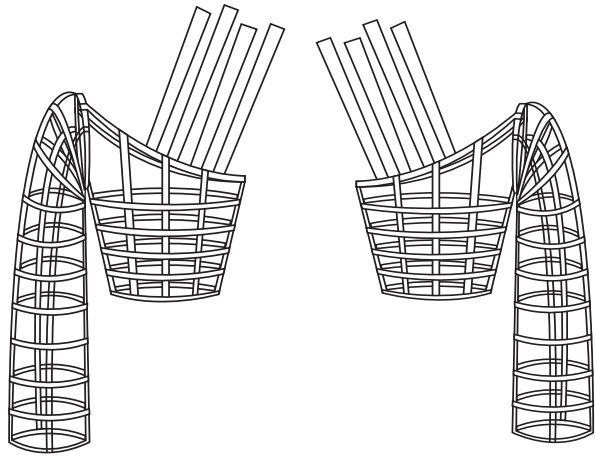
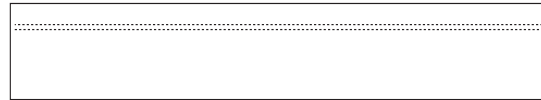

REDUCING THE
MOVEMENT OF
THE PERSON,
BUT GIVING IT
TO THE
FABRIC.



CAGE SHORTS

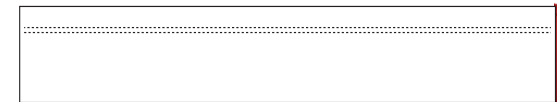
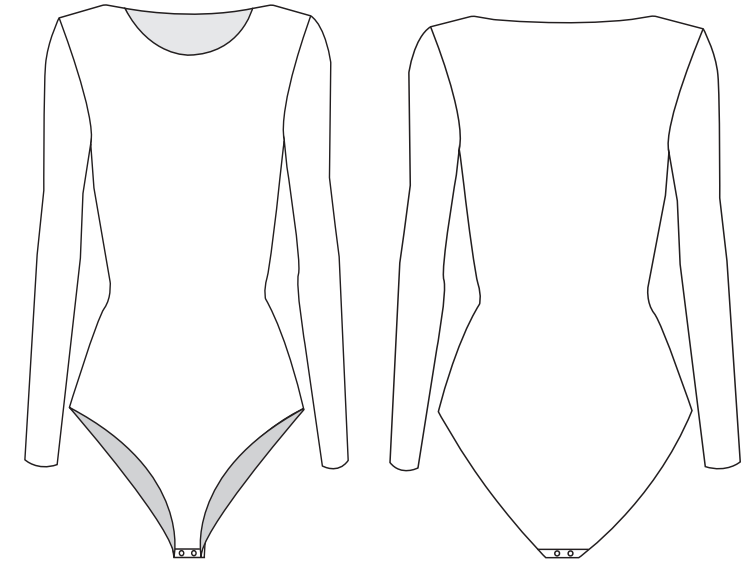

4 metres length by 20 cm width
make 10
gather and hand stitch to cage shorts

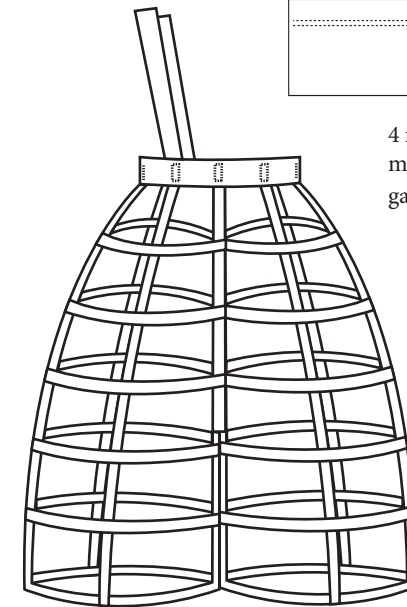
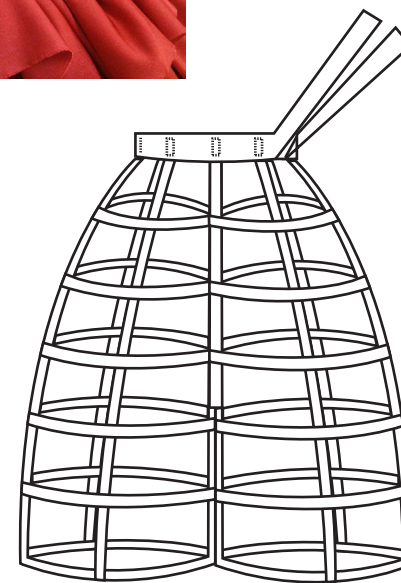

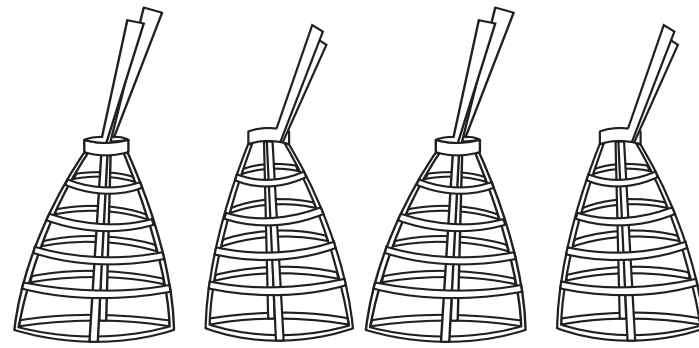
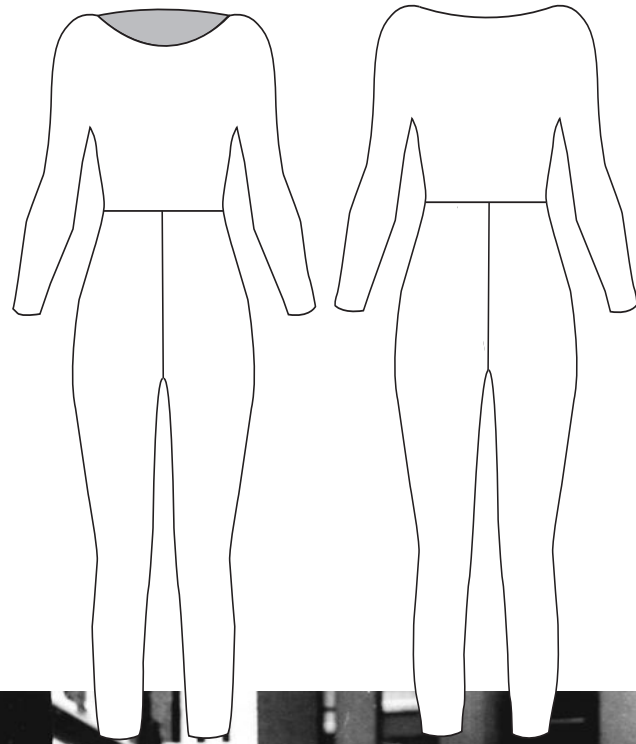

3 metres length by 20 cm width
make 10
gather and hand stitch to cages

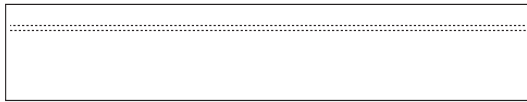



4 metres length by 20 cm width
 make 15
 gather and hand stitch to cage trousers

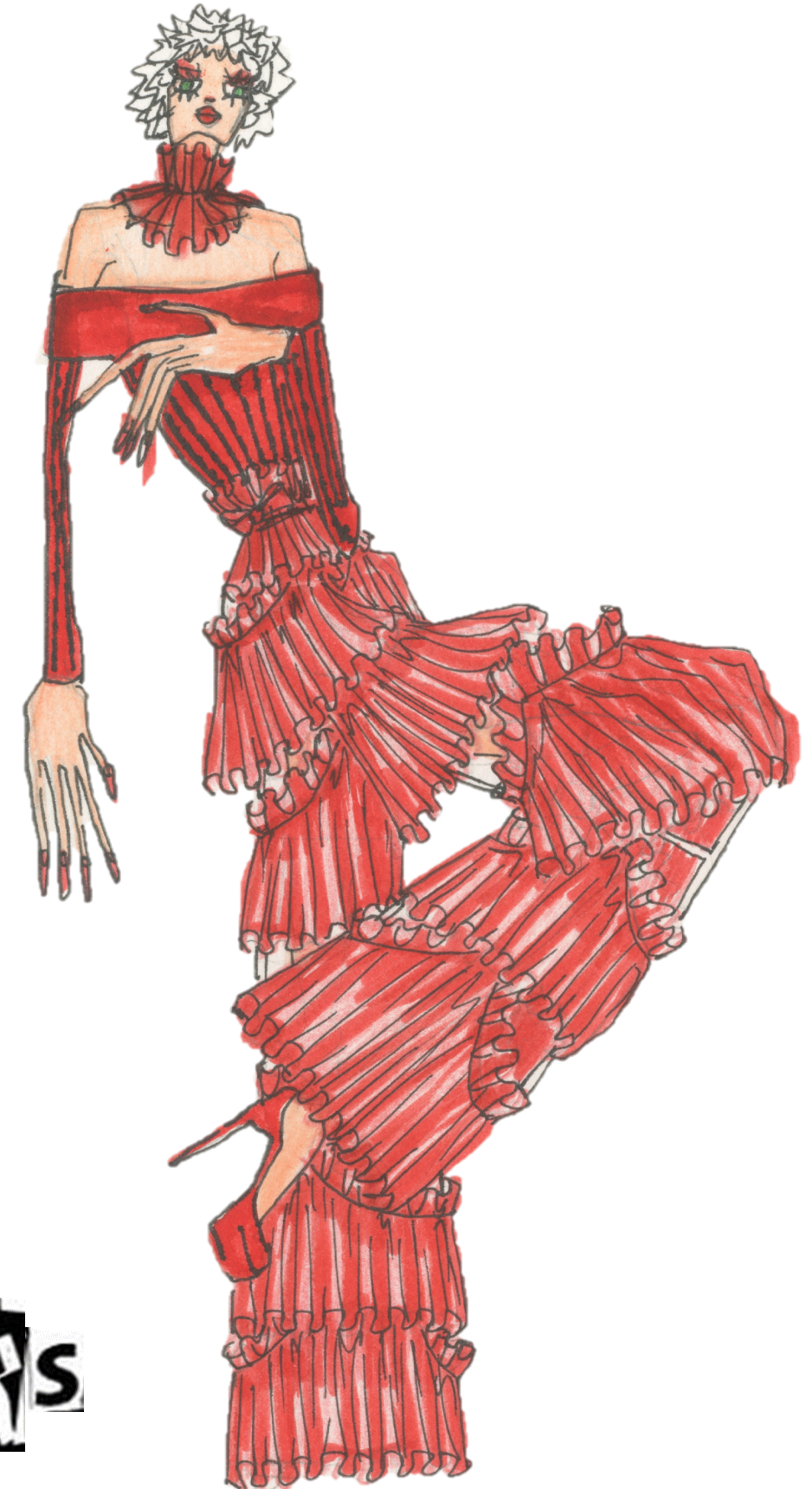

CAGE TROUSERS

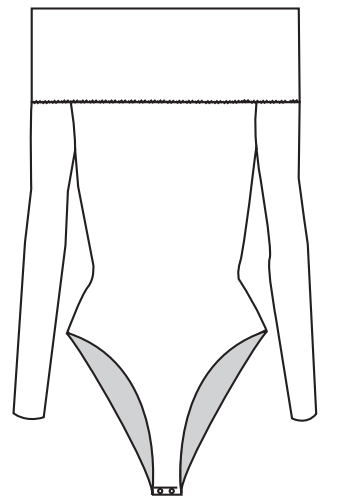
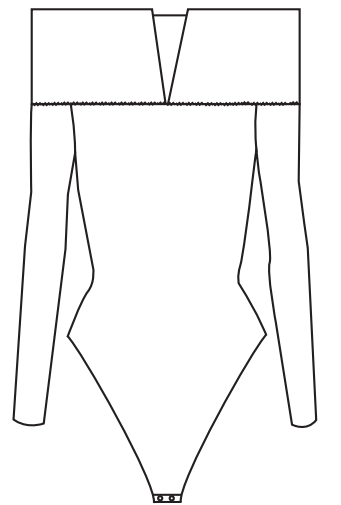
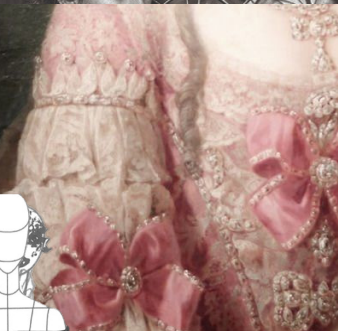
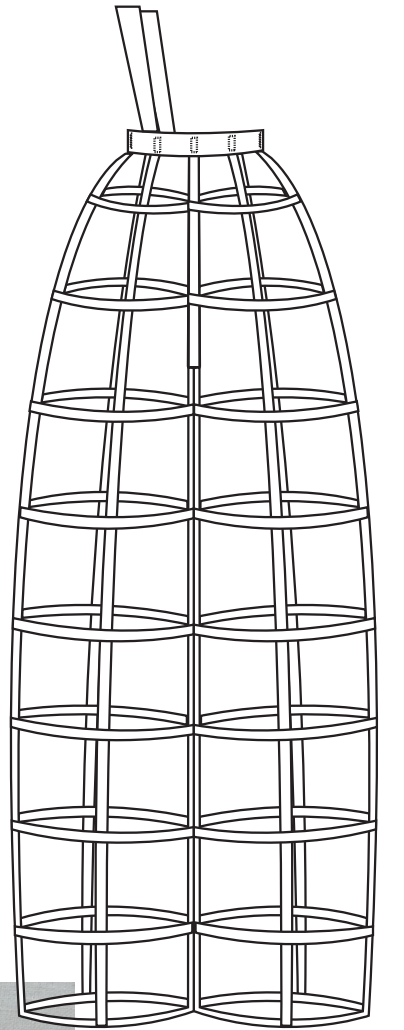
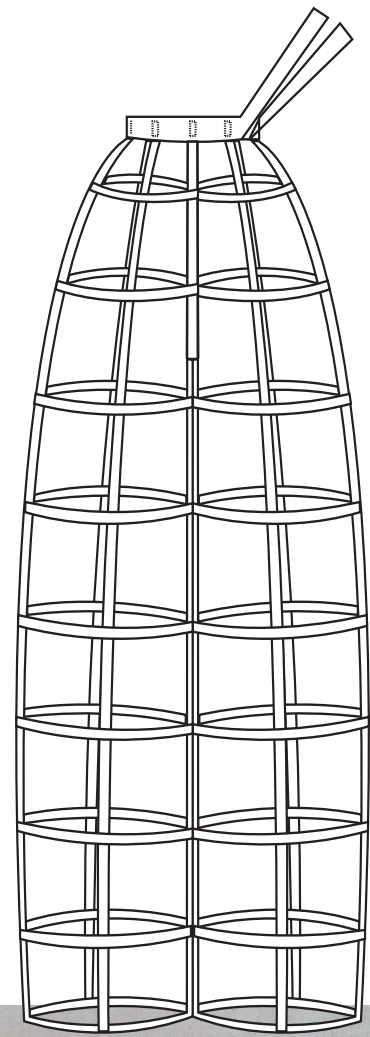
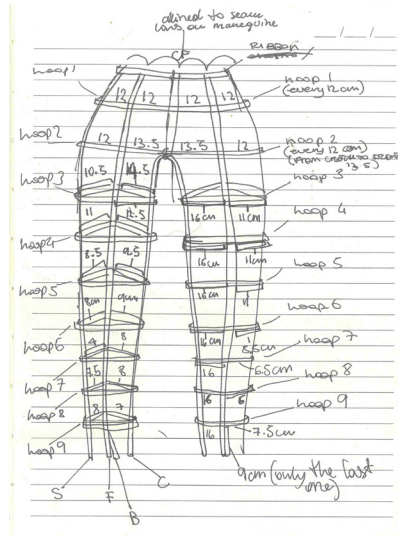



4 metres length by 20 cm width
make 10
gather and hand stitch 5 to cage gilet and 5 to
jumpsuit



CAGE GILET

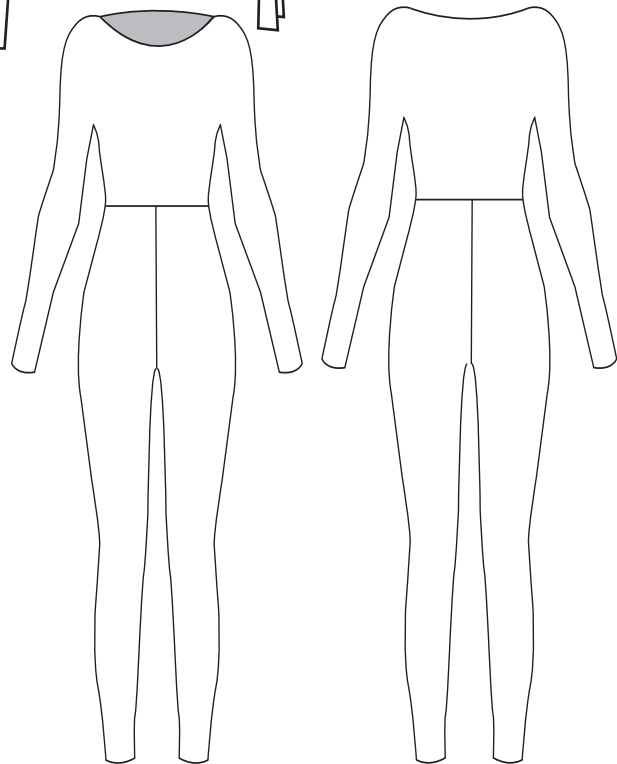
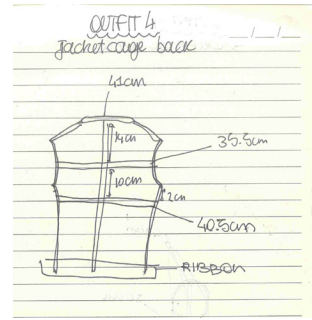
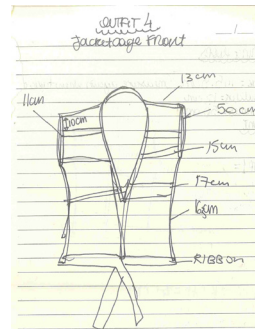
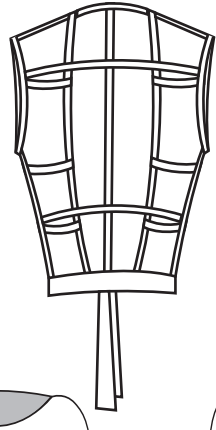
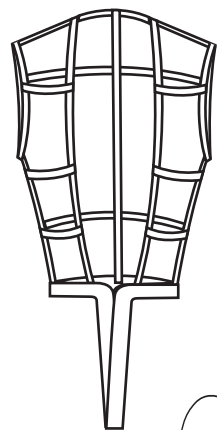





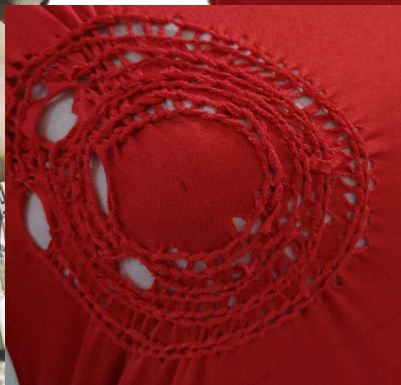
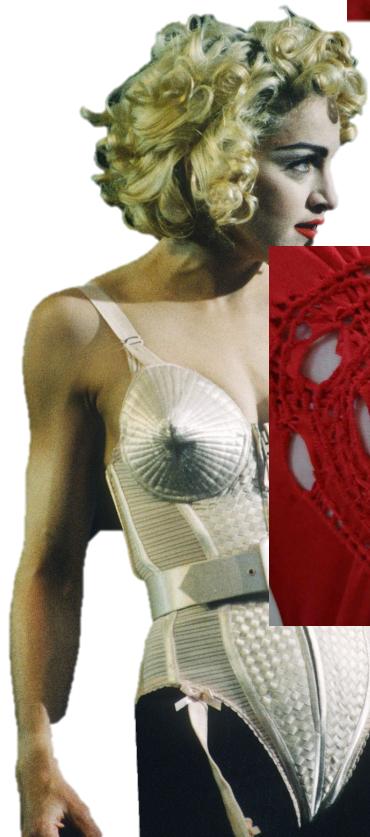
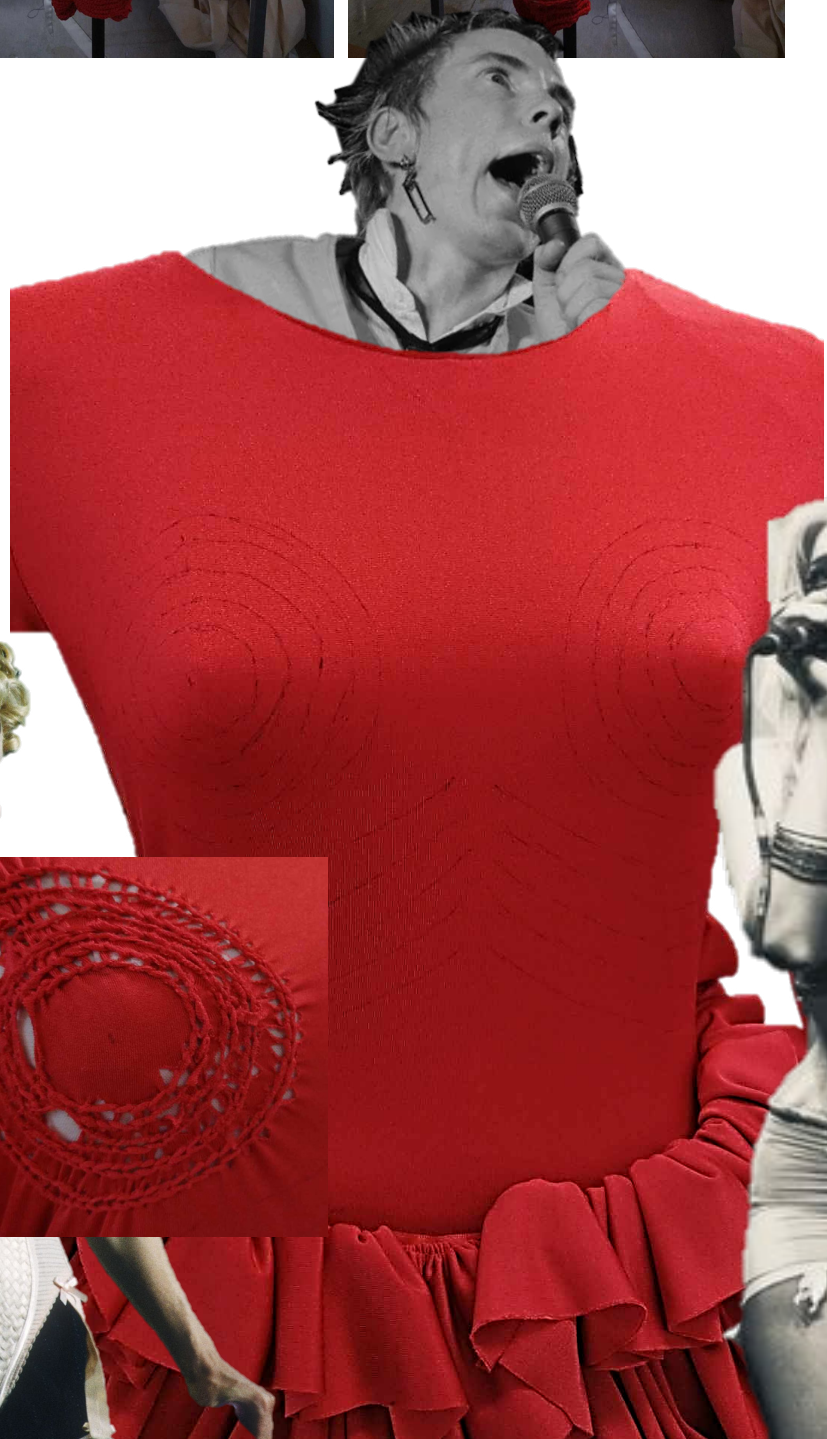
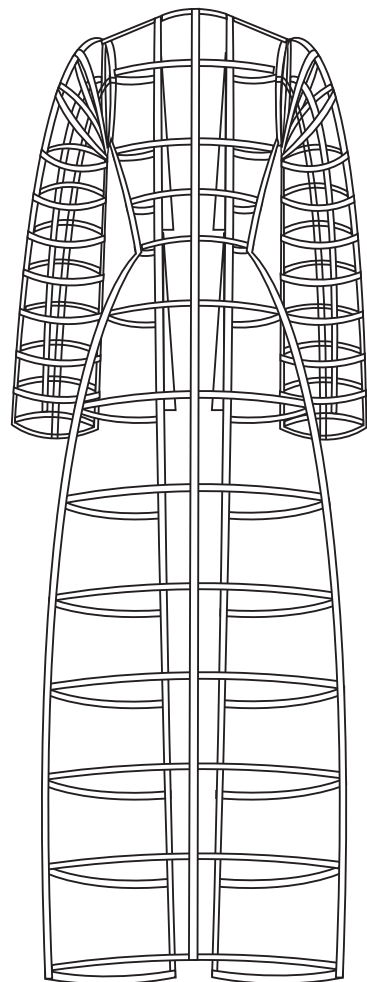
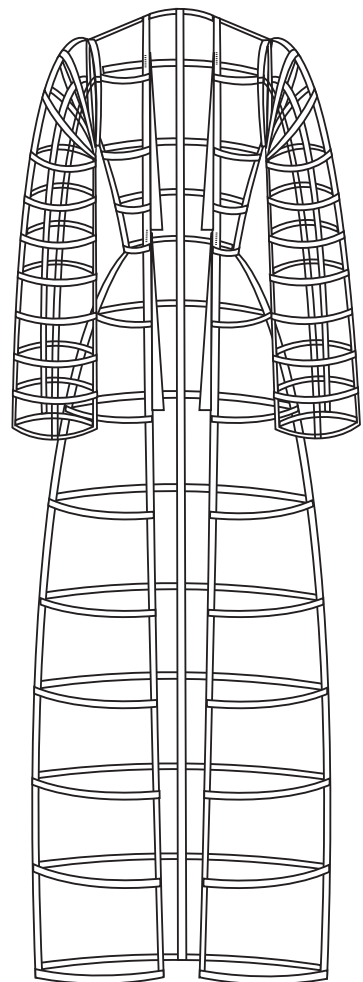
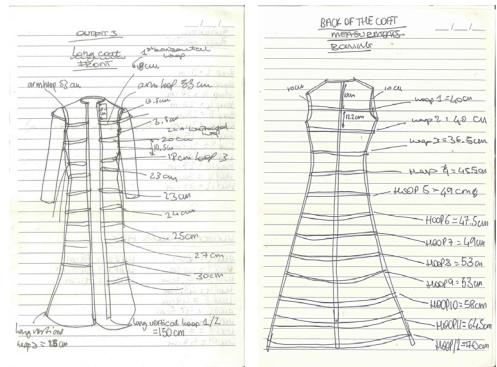
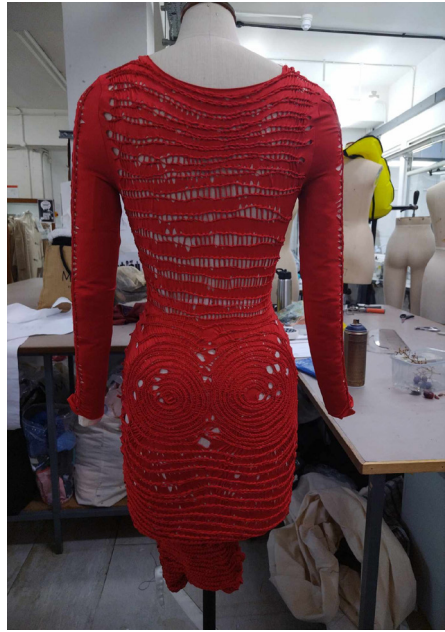
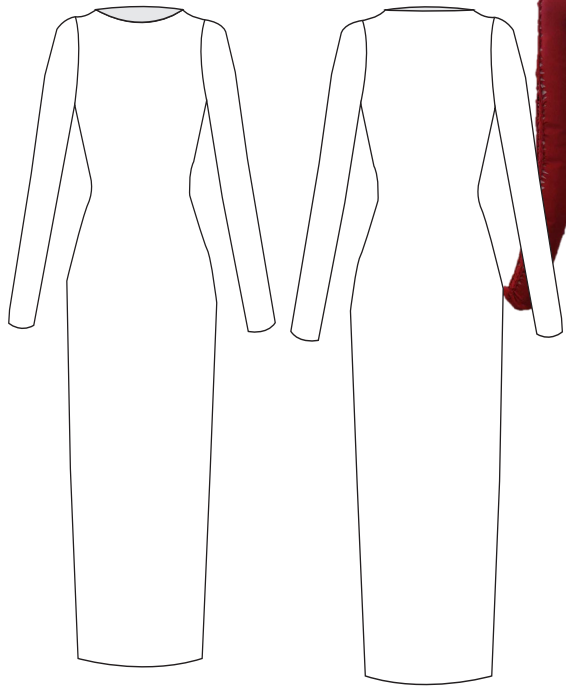

4 metres length by 20 cm width
make 20
gather and hand stitch to cage jacket

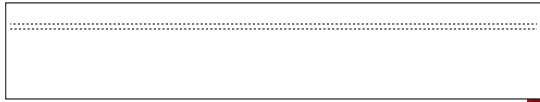

CAGE COAT

